

Article number: 2011381060

Description: E+G stainless steel-ball lock pin
GN 113.8-10-60

Measures

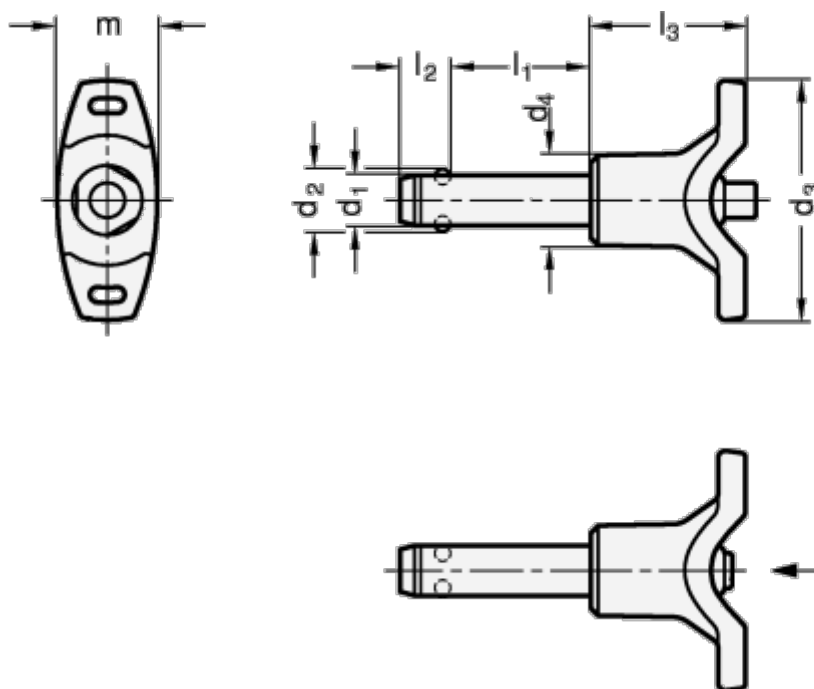

d1 = 10
d2 = 12.0
d3 = 48
d4 = 18.0
l1 = 60
l2 = 9.6
l3 = 31.0
m = 20.5

Resilience (N) = 100